



Affordable Cleaning You Can Rely On

Phone: 262-833-4040 Toll Free: 877-401-0730 www.timberlineclean.com



WALK-BEHIND SCRUBBERS RANGE

S | M | L | XL

Handmade In & Imported From Wisconsin, USA

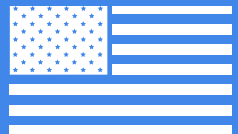



Small S-Series

Clean in hard to reach areas with this small-footprint walk behind floor scrubber. Especially agile and quiet for congested areas.

- Up to 40,000 sqft Per Charge
- 12 / 15 Gallons
- 17 - 20 inch decks

Applications

- Convenience Stores
- Auto-Truck Dealers
- Fitness Centers



Medium M-Series

Additional productivity and capacity on a mid-sized walk behind scrubber. Pass easily through small doorways or elevators, with this versatile and durable platform.

- Up to 70,000 sqft Per Charge
- 16 / 16 Gallons
- 20 - 28 inch decks

Applications

- Education
- Healthcare



Large L-Series

Reduce your time and labor cost to clean with this larger walk behind scrubber. Clean large areas simply and with predictable results.

- Up to 110,000 sqft Per Charge
- 19 / 19 Gallons
- 24 - 28 inch decks

Applications

- Healthcare
- Grocery
- Education



Extra Large XL-Series

Our maximum capacity and run time built with contract cleaners and large retail shopping areas in mind. Retains manageable footprint with excellent lines of sight for all operators.

- Up to 128,000 sqft Per Charge
- 25 / 26 Gallons
- 24 - 32 inch decks

Applications

- Grocery
- Retail
- Airports

Size Comparison Chart

-  = S-Series
-  = M-Series
-  = XL-Series

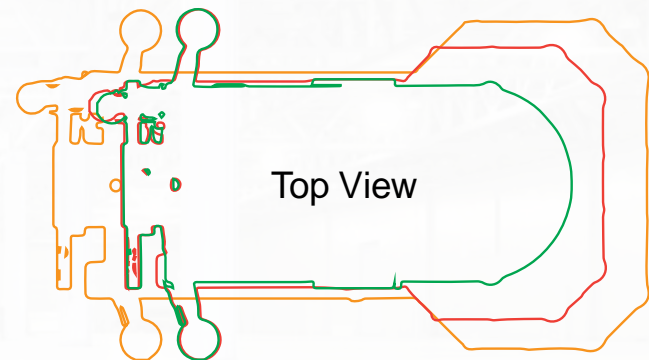
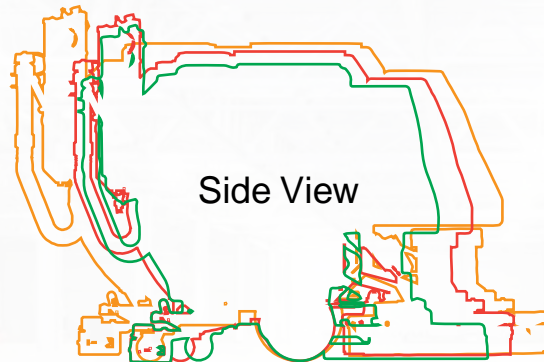

Specifications and features subject to change without notice.

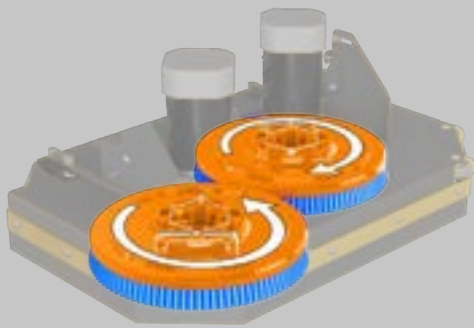

Disk

Benefits

- Brush / Pad Selection
- Lowest Maintenance Cost
- Improved Cleaning on Irregular Floors
- Brushes Individually Driven for Unmatched Performance

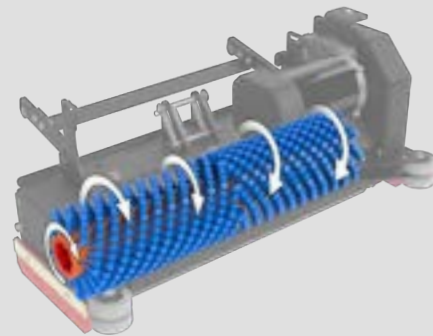

Grout

Benefits

- Ideal for grouted tile floors
- Compact for maneuverability
- Single brush simplicity
- Suitable for rubber athletic floors

*Only available on S-Series, no Debris Hopper.

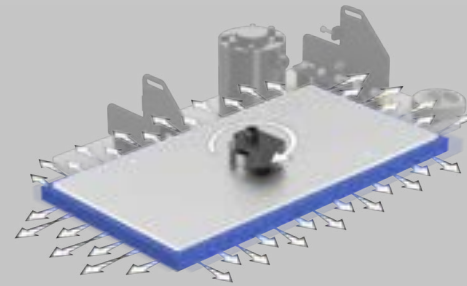

Orbital

Benefits

- Chemical Free Stripping
- Reduce Slip & Fall Potential
- 70% Reduction in Water Usage
- Consistent Results - No Swirl Marks
- VCT Prep & Recoat

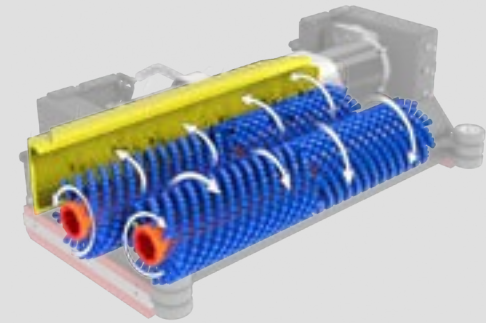

Cylindrical

Benefits

- Eliminates Dust Mopping
- Scrub & Sweep Simultaneously*
- Superior Tile & Grout Cleaning
- Excellent on Rubber Surfaces
- Great for Indoor Track Fields

*Only available on M-Series, L-Series, & XL-Series



26" Disk Deck on M Chassis Shown



24" Grout Deck on S Chassis Shown



24" Orbital Deck on M Chassis Shown



26" Cylindrical Deck on M Chassis Shown

PICK THE OPTIONS



Drain Savers & Deluxe Fill Options

Conveniently fill the floor scrubber fresh water tank from any standard faucet with the 60 inch retractable hose.



Onboard Charger

Charge anywhere in the facility with a plug and forget charger. LED Indicator lights shows state of charge and historic charge cycle data can be downloaded for review.



WET / AGM Battery Options

Choose between a variety of battery options for optimal run and charge times based on the application and needs.

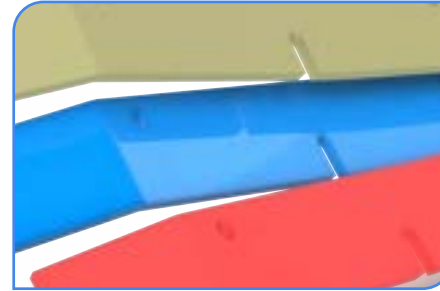

Squeegee Blade Variations

Different applications require different squeegee material to get the job done.

- Gum Rubber
- Urethane
- Linatex®

PICK THE BRUSH

- ① Nylon: White / Light - Soft
- ②* Polypropylene: Black / Medium - Light
- ③ Light Grit: Grey / Medium
- ④ Midi Grit: Blue / Rough
- ⑤* Tough Grit: Black / Very Rough
- ⑥* Tufted Pad Driver: Red / Variety Pads

*Not offered on Cylindrical Brushes



Education



K12 and university facilities come under increasing pressure to maintain cleanliness standards and protect their students and faculty. Our floor cleaning equipment is easy to use and reliable, so the daily chores of cleaning can be done without interruption.

Healthcare



In addition to expectations of superior cleaning and drying of the floor, our equipment is designed to be especially quiet and maneuverable. These features allow our equipment to safely operate in congested areas, and without disturbing the public.

Retail - Grocery



Our American made and durable equipment offers the highest value to retail and grocery clients, who often have strict budget to work with. Our value priced machines save customers money at the date of purchase, but also offer years of savings due to higher reliability and non-proprietary parts when service is necessary. Any technician with basic understanding of battery powered equipment could conduct repairs.

Hotels & Hospitality



The simple controls of our machines and excellent visibility from the operator's position make it easy for new users to gain confidence and productivity. Our rugged machines have soft corners and wall rollers standard to protect your facility and goods when operating up close. Extra consideration was given to water control and low sound levels, recognizing many clients operate facilities that are open 24/7

SPECIFICATIONS



Small S-Series

| | |
|--|---|
| Disk Scrub Path: | 17 & 20 in 43 & 51 cm |
| Grout Path: | 24 in 61 cm |
| Orbital Path: | 20 & 24 in 51 & 61 cm |
| Dimensions (LxWxH): | 49.5 x 22.5 x 38 in* 125 x 64 x 96 cm* |
| <small>*Dimensions listed are for the largest width deck configuration and squeegees removed from the machine.</small> | |
| Solution Tank: | 12 Gal 45 L |
| Recovery Tank: | 15 Gal 57 L |
| Demisting Chamber: | 1 Gal 4 L |
| Run Time: | Up to 2 Hours* |
| <small>*Based on continuous scrubbing run times, standard batteries, low down pressure and all options off.</small> | |
| Theoretical Coverage: | 20,000 sqft/hr* 1,858 sqm/hr* |
| <small>*Coverage is based off of ISSA 2010 Cleaning Times</small> | |
| Practical Coverage: | 9,500 sqft/hr* 882 sqm/hr* |
| <small>*Coverage is based off of ISSA 2010 Cleaning Times</small> | |



Medium M-Series

| | |
|--|---|
| Disk Scrub Path: | 20, 26 & 28 in 51, 66 & 71 cm |
| Cylindrical Path: | 26 in 66 cm |
| Orbital Path: | 24 & 28 in 61 & 71 cm |
| Dimensions (LxWxH): | 53 x 29 x 38.5 in* 135 x 74 x 98 cm* |
| <small>*Dimensions listed are for the largest width deck configuration and squeegees removed from the machine.</small> | |
| Solution Tank: | 16 Gal 60 L |
| Recovery Tank: | 16 Gal 60 L |
| Demisting Chamber: | 1 Gal 4 L |
| Run Time: | Up to 2.5 Hours* |
| <small>*Based on continuous scrubbing run times, standard batteries, low down pressure and all options off.</small> | |
| Theoretical Coverage: | 28,000 sqft/hr* 2,601 sqm/hr* |
| <small>*Coverage is based off of ISSA 2010 Cleaning Times</small> | |
| Practical Coverage: | 12,800 sqft/hr* 1,189 sqm/hr* |
| <small>*Coverage is based off of ISSA 2010 Cleaning Times</small> | |



Large L-Series

| | |
|--|---|
| Disk Scrub Path: | 26 & 28 in 66 & 71 cm |
| Cylindrical Path: | 26 in 66 cm |
| Orbital Path: | 24 & 28 in 61 & 71 cm |
| Dimensions (LxWxH): | 53 x 29 x 38.5 in* 135 x 74 x 98 cm* |
| <small>*Dimensions listed are for the largest width deck configuration and squeegees removed from the machine.</small> | |
| Solution Tank: | 19 Gal 72 L |
| Recovery Tank: | 19 Gal 72 L |
| Demisting Chamber: | 1 Gal 4 L |
| Run Time: | Up to 3.5 Hours* |
| <small>*Based on continuous scrubbing run times, standard batteries, low down pressure and all options off.</small> | |
| Theoretical Coverage: | 31,428 sqft/hr* 2,919 sqm/hr* |
| <small>*Coverage is based off of ISSA 2010 Cleaning Times</small> | |
| Practical Coverage: | 14,857 sqft/hr* 1,380 sqm/hr* |
| <small>*Coverage is based off of ISSA 2010 Cleaning Times</small> | |



Extra Large XL-Series

| | |
|--|--|
| Disk Scrub Path: | 28 & 32 in 71 & 81 cm |
| Cylindrical Path: | 26 & 30 in 66 & 76 cm |
| Orbital Path: | 24 & 28 in 61 & 71 cm |
| Dimensions (LxWxH): | 62 x 33 x 39.5 in* 157 x 84 x 100 cm* |
| <small>*Dimensions listed are for the largest width deck configuration and squeegees removed from the machine.</small> | |
| Solution Tank: | 25 Gal 95 L |
| Recovery Tank: | 26 Gal 98 L |
| Demisting Chamber: | 2 Gal 9 L |
| Run Time: | Up to 4 Hours* |
| <small>*Based on continuous scrubbing run times, standard batteries, low down pressure and all options off.</small> | |
| Theoretical Coverage: | 32,000 sqft/hr* 2,973 sqm/hr* |
| <small>*Coverage is based off of ISSA 2010 Cleaning Times</small> | |
| Practical Coverage: | 15,000 sqft/hr* 1,393 sqm/charge* |
| <small>*Coverage is based off of ISSA 2010 Cleaning Times</small> | |

Specifications and features subject to change without notice.

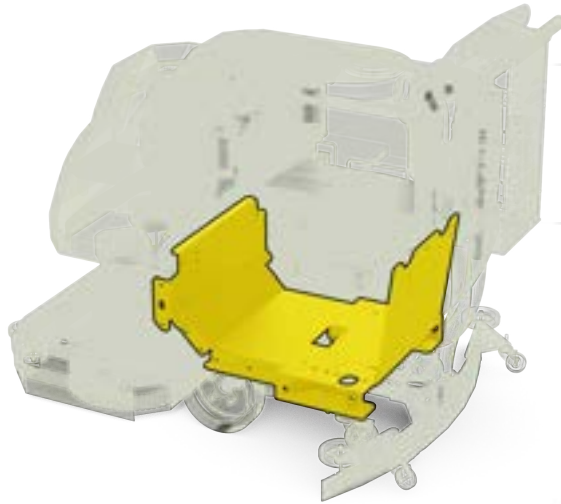

Like a heavy duty truck, the strong steel frame supports all of the systems and weight. The 4-point stance offers greater stability on irregular floors and those contact points bolt directly to the steel frame.

200 lb Capacity Sealed Actuator

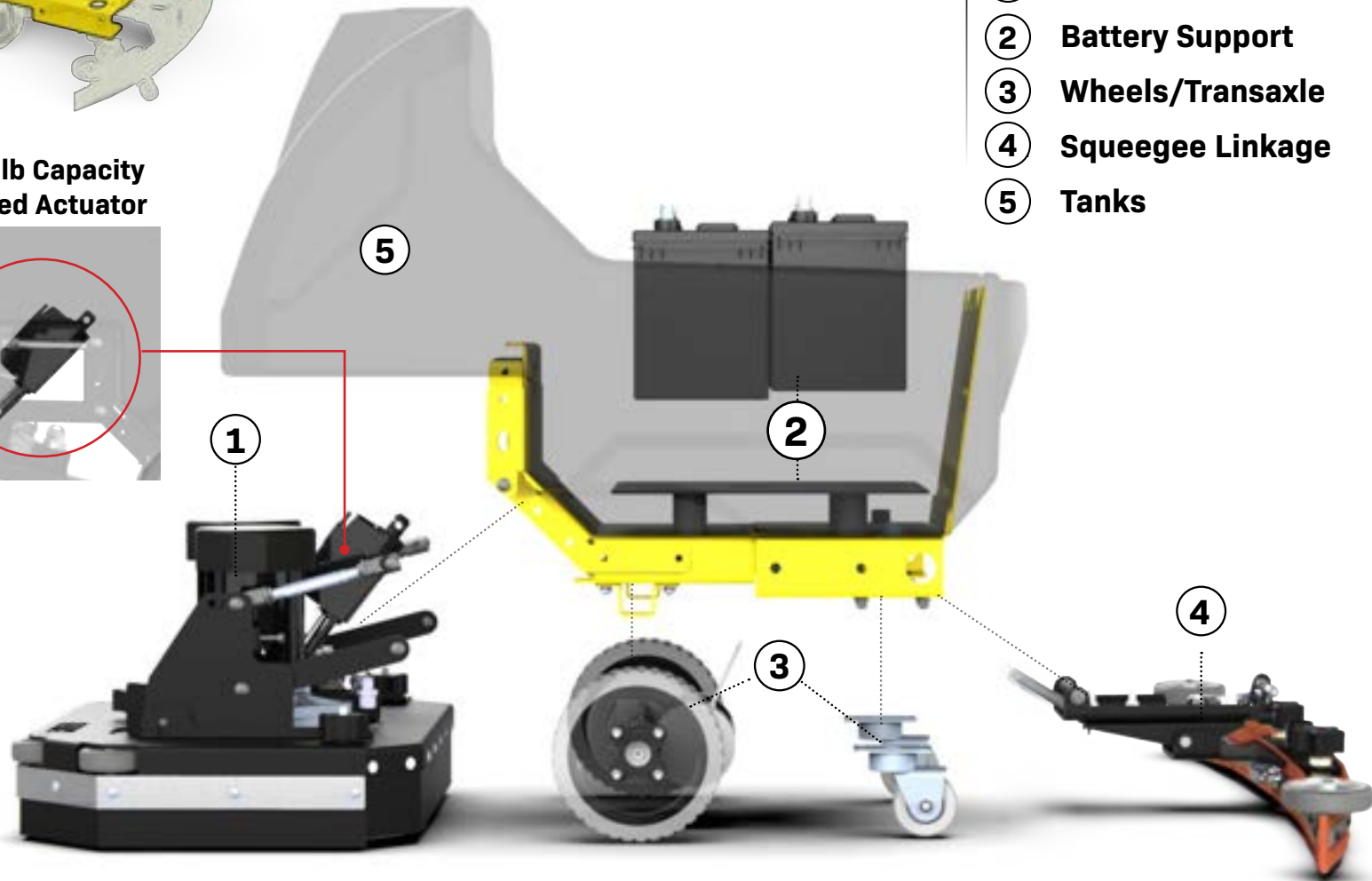
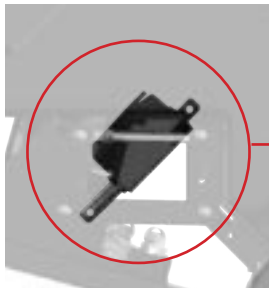

Steel Frame Attachments

- ① Scrub Deck
- ② Battery Support
- ③ Wheels/Transaxle
- ④ Squeegee Linkage
- ⑤ Tanks

RPS “through bolts” these assemblies to the steel frame, not the tanks. No tapped steel that could rust in time.

To protect the vacuum motor from intaking moisture, our equipment has five (5) individual protective barriers

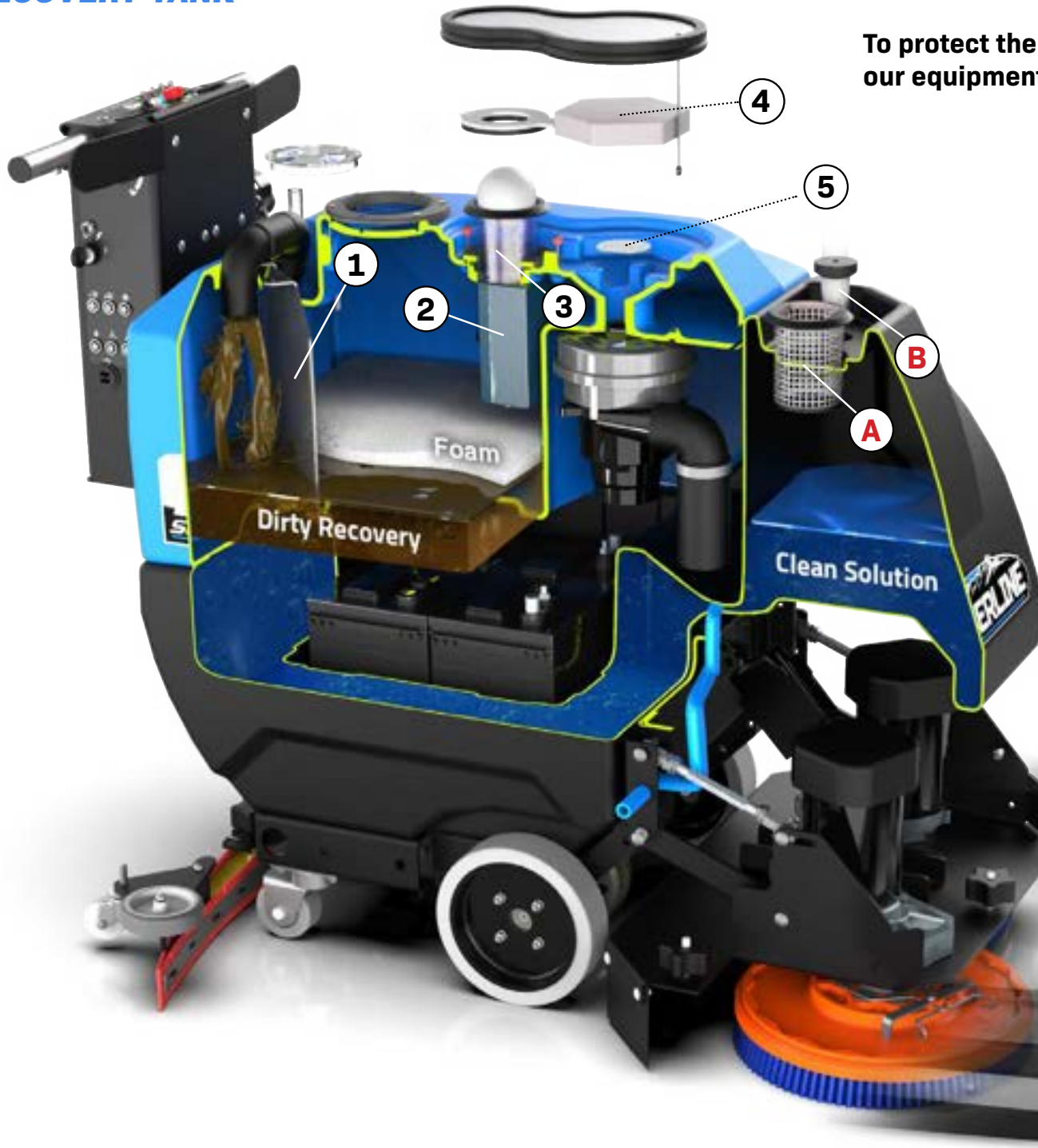

- ① Intake Curtain
- ② Shield
- ③ Stainless Vac Screen-Ball Float
- ④ White Mesh Filter
- ⑤ Stainless Screen

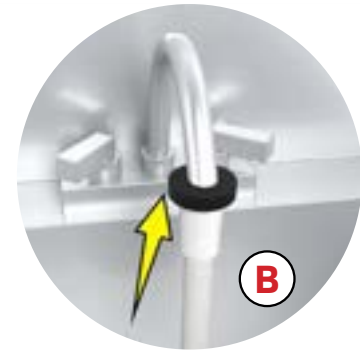

Operators can pour water into the large stainless screen through the large front funnel (A), or use the remote solution fill hose that attaches to most faucets (B).

Our central command components are simply designed making service easier than ever. We build our boxes out of steel, maintaining the integrity of the components and the machine.

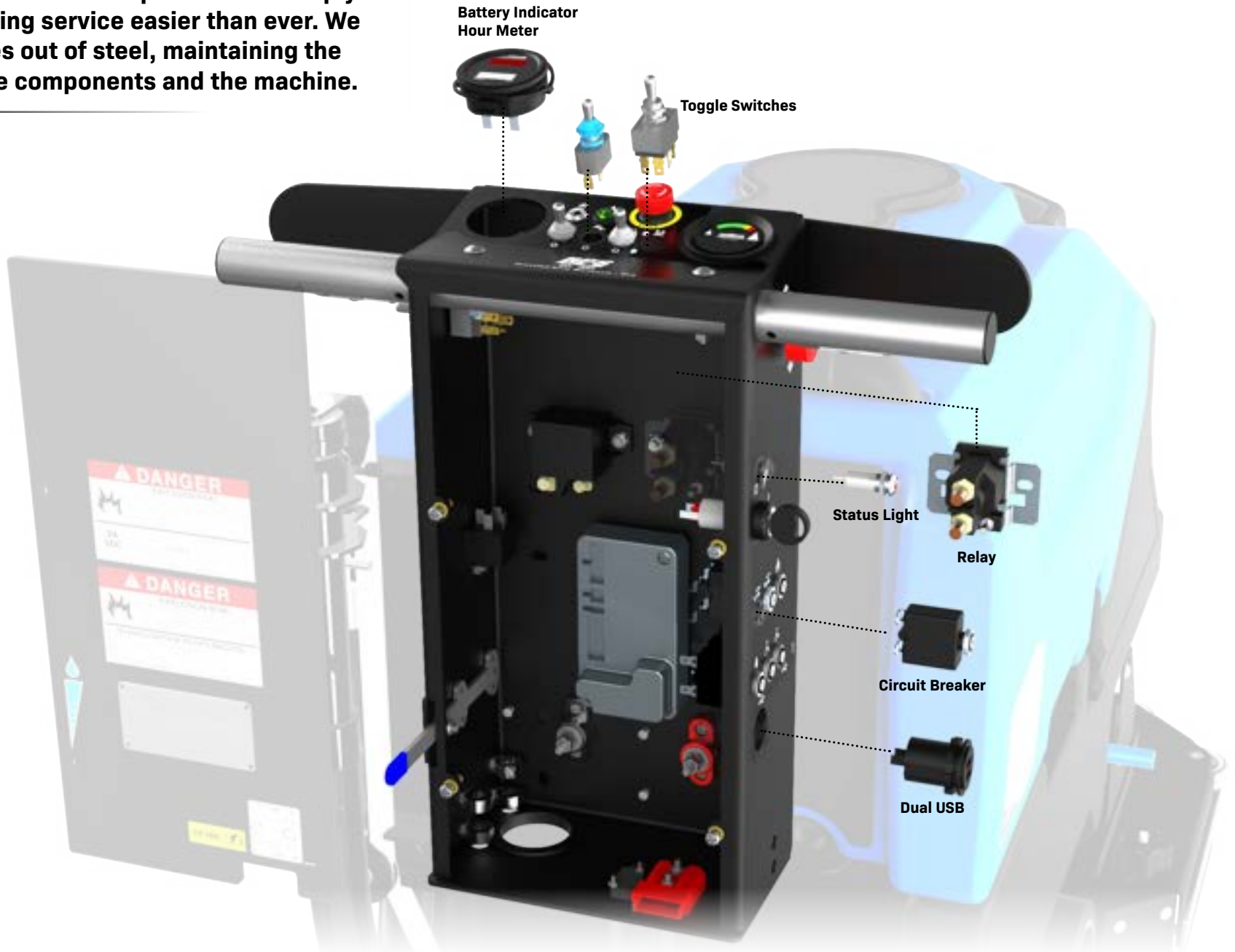

Patent pending design. If water or foam manages to get past the five protective barriers, our equipment directs the discharge out a hose to alert the operator and further guard the machine from damage.

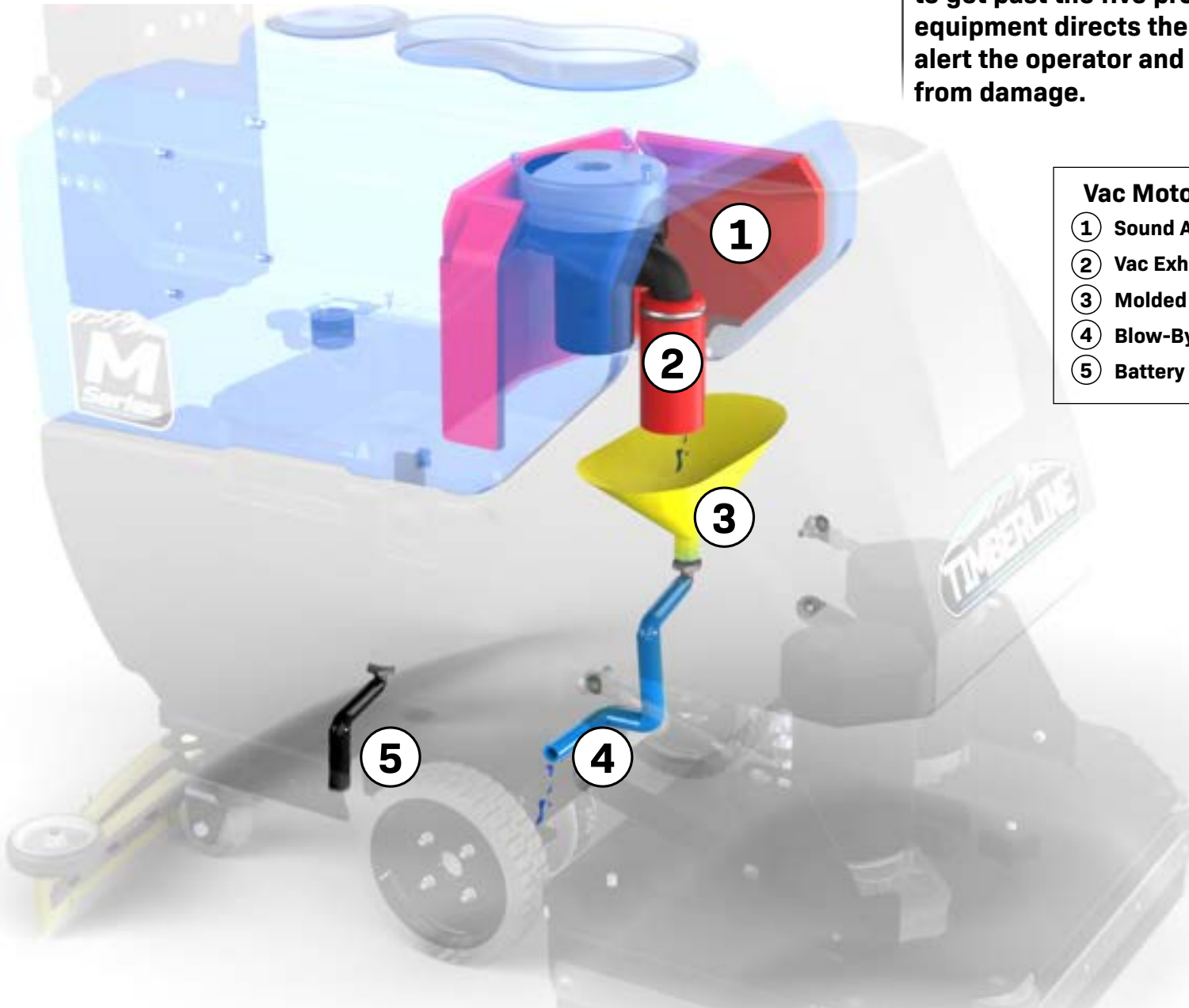

Vac Motor Blow-By

- ① Sound Absorbing Foam
- ② Vac Exhaust Muffler
- ③ Molded In-Tank Funnel
- ④ Blow-By Discharge Hose
- ⑤ Battery Box Drain Hose with valve

No loose fasteners

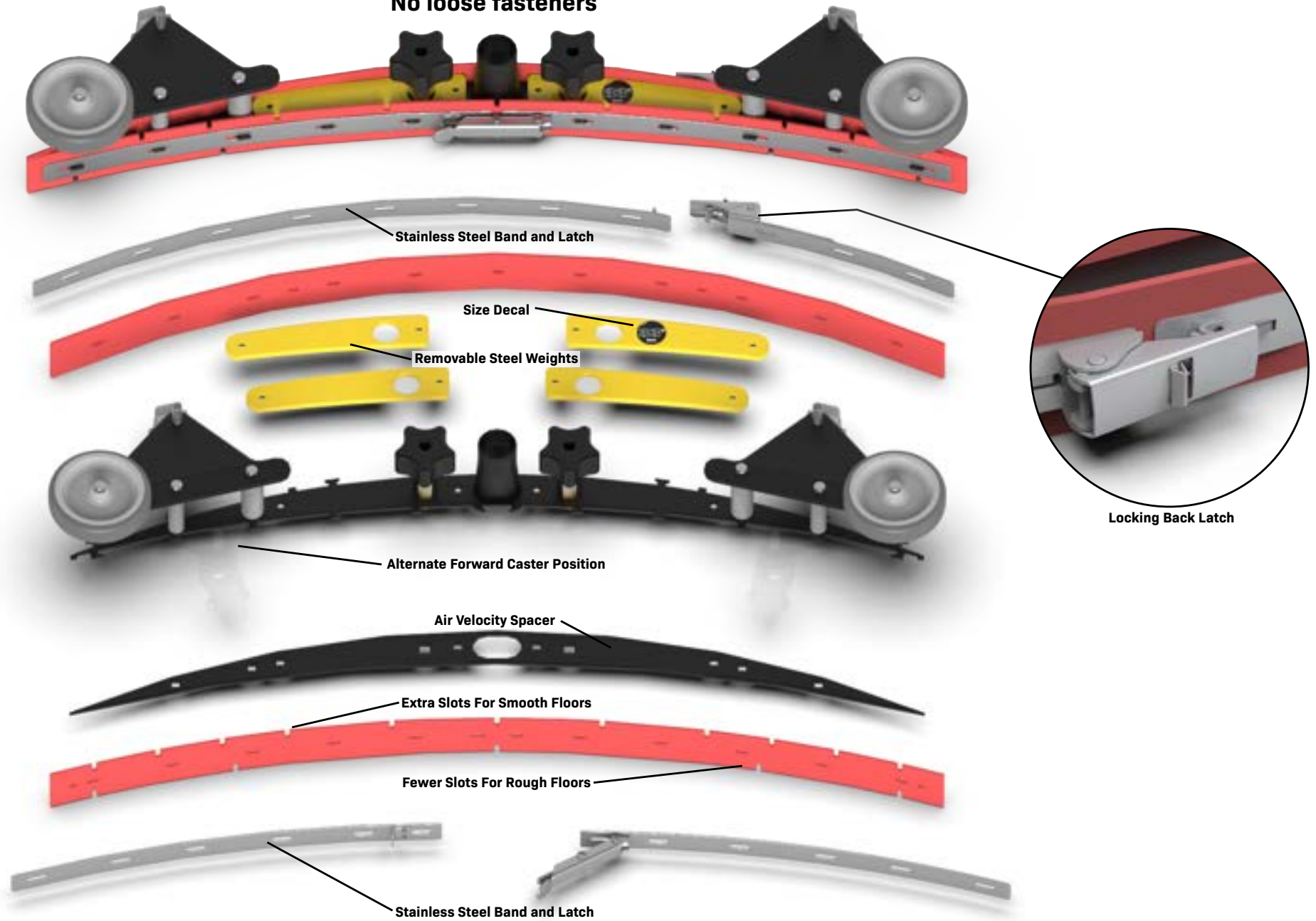

Our Family's American Dream

RPS has been family owned from its inception in 1986, and proudly builds in Wisconsin (USA). The company has grown over the last 35-years with a strong group of executives including the 2nd generation of family owners who started in the shop as youngsters.

Authorized Distributor



Assembled By Hand

Our American workforce hand-builds each machine with components sourced over 95% from American suppliers. We routinely pay more for these domestically supplied components required to build a superior product. All design, prototyping, production and testing is done in-house where we can best control quality.



Steel Fabrication

We produce heavy duty equipment and require a good amount of thick steel in the construction. We use a combination of Stainless 304 (Austenitic 18/8) and mild steel with e-coating + powder paint for corrosion resistance. Steel fabrication is done in-house or from local suppliers with specialty equipment.

Rotational Molding

Complex shapes that allow for our tank designs are best achieved with in-house equipment. We own multiple dual station rotational molding machines that allow us to produce finished parts from raw plastic. Producing consistently higher quality parts, and respond quickly to sales spikes.

Product Design

Our team has designed and engineered over 100 unique machines. Each new generation of machines evolve from prior designs to retain the strengths and correct any weakness. From the first pencil sketch we focus on durability, serviceability, performance, productivity, specifications, and value.